



BRIGHTLINK AV LTD
BRIGHTLINKAV.COM - 1-855-449-4733

USER'S MANUAL

models: BL-OD-TV-55-700, BL-OD-TV-55-1500, BL-OD-TV-65-700, BL-OD-TV-65-1500

brightlinkav.com



**BRIGHTLINK 4K60Hz High Brightness
IP55 Outdoor Smart TV**



Note: The product and illustrations in this user's manual is only for explanation purposes and may vary depending on model.

brightlinkav.com

General Information

To avoid damaging the television set please observe the following safety instructions during setup and use.

Cleaning the television set	Before cleaning, disconnect the television set. Use only a soft damp cloth or a special cleaning product for flat-screens.
LED Display	Too much pressure on the screen can damage the television set.
Heat/damp/humidity	The television set should not be exposed to high temperatures (radiators, open fire). The television set should not be used in areas with high humidity.
Condensation	If moved from a cool area to one with a higher temperature, the television set should be left for at least an hour before plugging it in. A rapid change of temperature can lead to the formation of condensation in the television set itself. This can lead to damage if the television set is in use.
Air Circulation	To prevent overheating of the television set the ventilation slots at the rear should always be clear.
Small Objects	It is important to ensure that no small objects or liquids enter the television set. They can cause damage or even fire.
Liquids/Candles	Do not place anything holding a liquid or any candles on the television set.
Crushing	Take care to avoid crushing fingers or other objects when turning the television set in any direction.
Electric Supply	Use the television set only with the voltage indicated in the specifications. Ensure that there is easy access to the plug and that the television set can always be disconnected from the electricity supply. Do not disconnect the television set by pulling the power cable. Always take hold of the plug. The power cable must not be kinked or placed over sharp edges.
Moving the Television Set	When moving the television set, hold only the casing.
Repairs/Accessories	Repairs and servicing must be undertaken only by authorised and trained personnel.
	In accordance with the Batteries Regulation, batteries are to be disposed of only in containers provided for this purpose.



In extreme weather (storms, lightning) and long inactivity periods (going on holiday) disconnect the TV set from the mains. The mains plug is used to disconnect TV set from the mains and therefore it must remain readily operable. If the TV set is not disconnected electrically from the mains, the device will still draw power for all situations even if the TV is in standby mode or switched off.

IMPORTANT - Please read these instructions fully before installing or operating
WARNING: Never let people (including children) with reduced physical, sensory or mental capabilities or lack of experience and / or knowledge use electrical devices unsupervised.

- The TV set is intended for Outdoor and similar general use but may also be used in public places.
- For ventilation purposes, leave at least 5cm of free space around the TV.
- The ventilation should not be impeded by covering or blocking the ventilation openings with items, such as newspapers, table-cloths, curtains, etc.
- The power cord plug should be easily accessible. Do not place the TV, furniture, etc. on the power cord. A damaged power cord/plug can cause fire or give you an electric shock. Handle the power cord by the plug, do not unplug the TV by pulling the power cord. Never touch the power cord/plug with wet hands as this could cause a short circuit or electric shock. Never make a knot in the power cord or tie it with other cords. When damaged it must be replaced, this should only be done by qualified personnel.
- Do not expose the TV to dripping or splashing of liquids and do not place objects filled with liquids, such as vases, cups, etc. on or over the TV (e.g., on shelves above the unit).
- Do not do not place open flames such as lit candles on the top of or near the TV.
- Do not place any heat sources such as electric heaters, radiators, etc. near the TV set.
- Do not place the TV on the floor and inclined surfaces.
- To avoid danger of suffocation, keep plastic bags out of the reach of the babies, children and domestic animals.
- Do not dispose of the batteries in fire or with hazardous or flammable materials.
- Warning: Batteries must not be exposed to excessive heat such as sunshine, fire or the like.
- If you think batteries might have been swallowed or placed inside any part of the body, seek immediate medical attention.

WARNING

Never place a television set in unstable or inclined locations. A television set may fall, causing serious personal injury or death. Many injuries, particularly to children, can be avoided by taking simple precautions such, Educating children about the dangers of climbing on furniture to reach the television set or its controls.

WALL MOUNTING WARNINGS

Read the instructions before mounting your TV on the wall.

The wall mount kit is optional.

Do not install the TV on a ceiling or on an inclined wall.

Use the specified wall mounting screws and other accessories.

Tighten the wall mounting screws firmly to prevent the TV from fall. Do not over-tighten the screws.

WARNING

This is not a recessed installable TV, Do not insert TV into the wall.

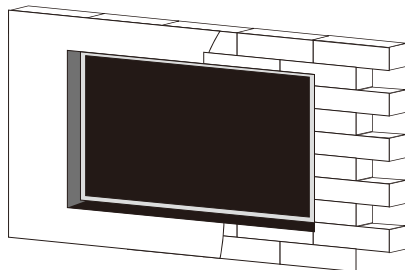

Accessories

Please make sure the following items are included with your TV.
 If any items are missing, Please contact us.



Remote Control

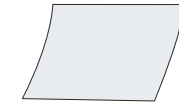

Warranty Card

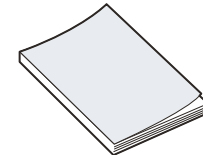

User's manual

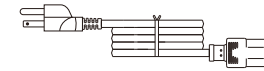

Power Cord

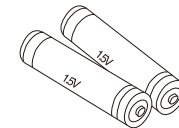

Batteries (AAAx 2)



Screws BM8X14MM

(Matched with Sylvox Full Motion Cantilever Mount)



Screws BM8X28MM & Gasket

(Matched with Fixed Wall Mount)

Content

TV Specification	1
Installation	2~4
Overview	5
Remote-Control unit	6~8
Main Menu User Guide	
Picture	11
Sound	12-13
Setting	14-15
Lock	16
Program	17-18
Network	19
About	20
Home Operation	21-25
Troubleshooting	26-27

TV Specification

Screen size	43"
Display Type	TFT LED
Resolution	3840 X 2160
Aspect Ratio	16:9
Alimentation	AC 100-240V 50/60Hz
Audio Output	L/R 10W X 2
Dimensions	38.40 x 22.56 x 3.45 inch
Operating Temperature	-22° to 122° F (-30° to 50°C)

Screen size	55"
Display Type	TFT LED
Resolution	3840 X 2160
Aspect Ratio	16:9
Alimentation	AC 100-240V 50/60Hz
Audio Output	L/R 10W X 2
Dimensions	48.98 x 28.60 x 3.45 inch
Operating Temperature	-22° to 122° F (-30° to 50°C)

Screen size	65"
Display Type	TFT LED
Resolution	3840 X 2160
Aspect Ratio	16:9
Alimentation	AC 100-240V 50/60Hz
Audio Output	L/R 10W X 2
Dimensions	57.61 x 33.45 x 3.45 inch
Operating Temperature	-22° to 122° F (-30° to 50°C)

Screen size	75"
Display Type	TFT LED
Resolution	3840 X 2160
Aspect Ratio	16:9
Alimentation	AC 100-240V 50/60Hz
Audio Output	L/R 10W X 2
Dimensions	66.32 x 38.35 x 3.45 inch
Operating Temperature	-22° to 122° F (-30° to 50°C)

Note:

Design and specification modification maybe made at any time without prior notice, all data and dimensions are approximations.

Installation

Fixed Wall Mount



Screen size
43"/55"/65"/75"

Capacity
50Kg

VESA
700 x 400mm

Warning - Please read before installation
(Mounting Brackets are not supplied with TV)

Please thoroughly read instructions before attempting installation The only suitable for the 43"-75"Outdoor TVs.

We advise that 2 people install the screen due to the heavy load of the screens.

Please be sure the mounting surface is strong enough to hold the weight of the screen.

Installation

Step1-Mounting Bracket to Wall

Fix the horizontal bracket into wall with screws.

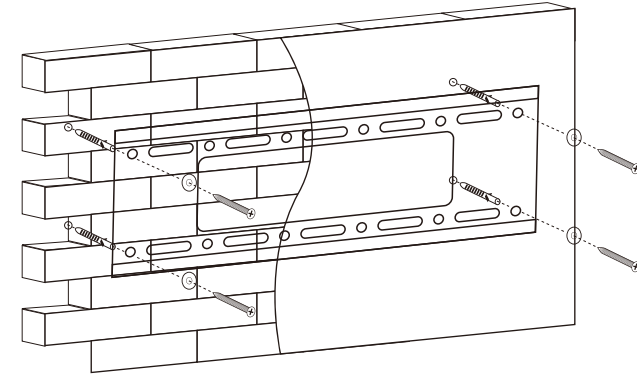

Step2-Mounting bracket to TV

Fix the vertical bracket on the back of TV with screws(M8).

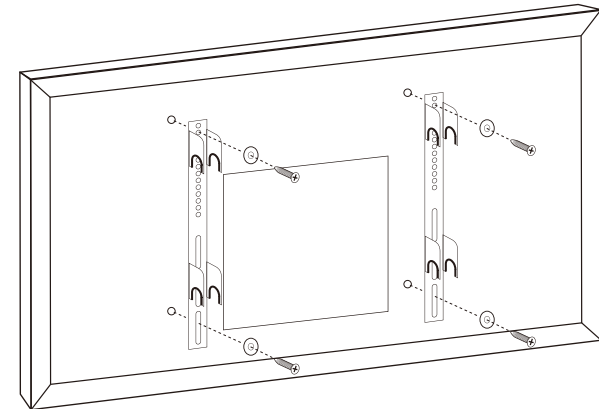

Installation

Step 3—Mounting TV to Bracket
Attach TV with brackets on wall.

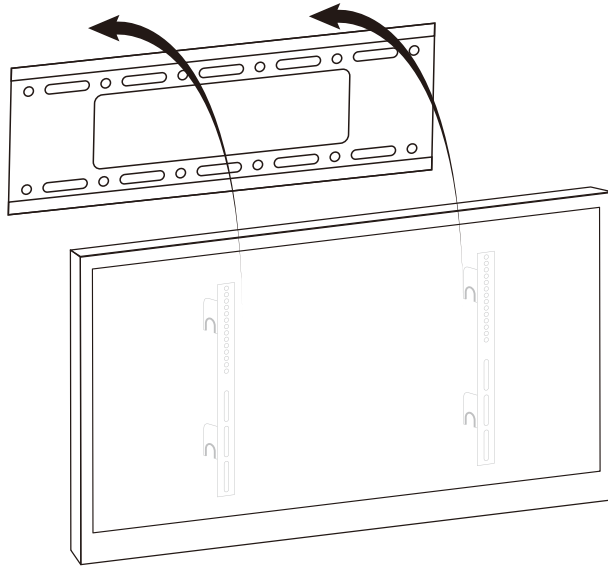

VESA Standard	43": 400 x 200 mm
	55": 400 x 200 mm
	65": 400 x 400 mm
	75": 600 x 400 mm

Overview



- ① Auto-brightness control sensor (1500cd/m² Series only)
Automatically adjust the screen brightness according to the ambient light.
- ② REMOTE CONTROL SENSOR
- ③ POWER INDICATOR
Green: In power on mode.
Red: In standby mode.

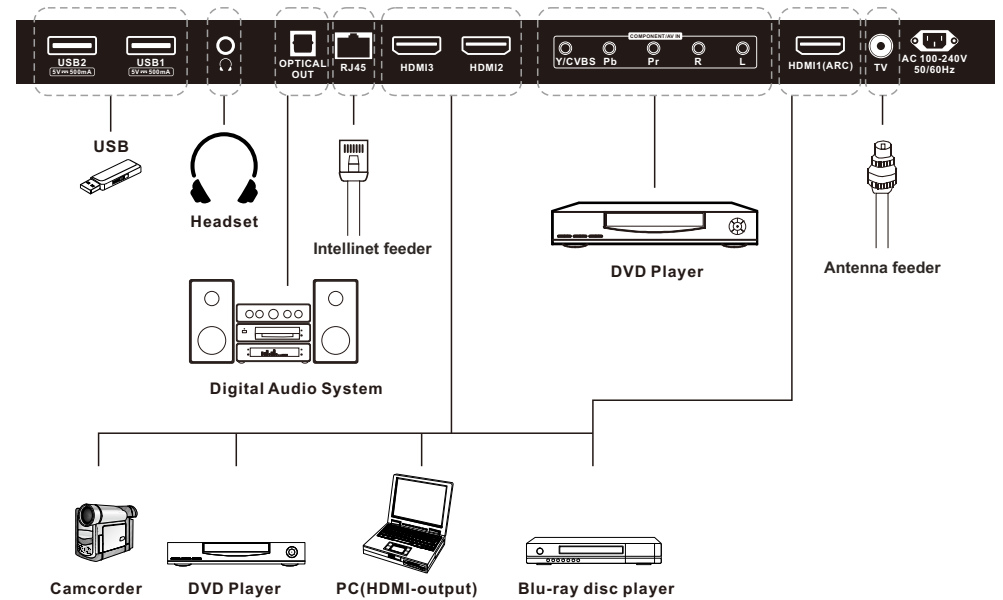

Remote-Control unit

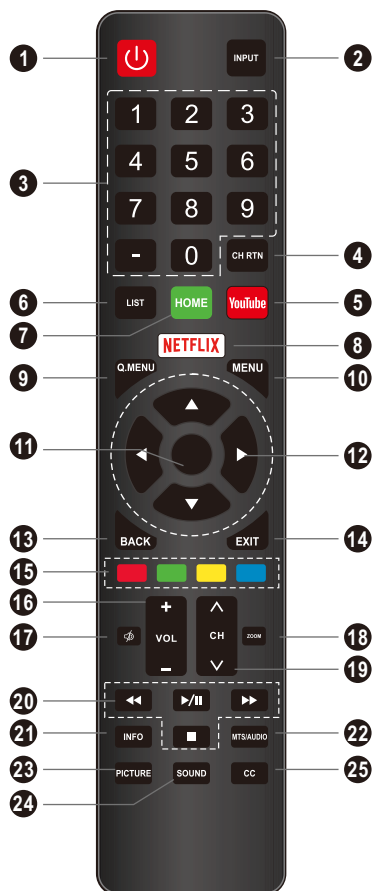

Loading batteries:

- 1) Remove the lid of the battery compartment.
- 2) Insert 2 size AAA batteries with polarities as indicated inside the compartment.
- 3) Replace the lid.

Note:

- 1) A loading of batteries should be last one year under normal use.
- 2) If you don't intend to use the remote control for a long period of time, remove batteries to avoid damage due to leakage.
- 3) Do not mix old and new batteries or different types.
- 4) Do not throw batteries into fire or water.
- 5) The batteries (battery pack or batteries installed) should not be exposed to excessive heat such as sunshine, fire or the like.

Remote-Control unit

1. POWER: Turn the TV on and off.

2. INPUT: This button is used to switch among different sources, Select a source and press ENTER button to confirm.

3. Digital Buttons(0-9, *): Directly select channel with digital buttons.

4. CH RTN: Switch to the previous program.

5. YouTube: If network connects, press this key to view YouTube directly.

6. LIST: Press it to show channel list and favorite list on screen.

7. HOME: Press it to go to App home page.

8. NETFLIX: If network connects, press this key to view NETFLIX directly.

9. Q.MENU: Press this key to go to quick menu.

10. MENU: Display the main menu or exit the current menu.

11. ENTER: Validation key.

12. Arrow buttons ◀▶▲▼: Use to select on-screen menu items and change menu values.

13. BACK: Return.

14. EXIT: Exit the menu.

15. COLOR BUTTONS: It's used as it's showed in the EPG or Program Edit menu.

16. VOL +/-: Press these buttons to adjust the volume.

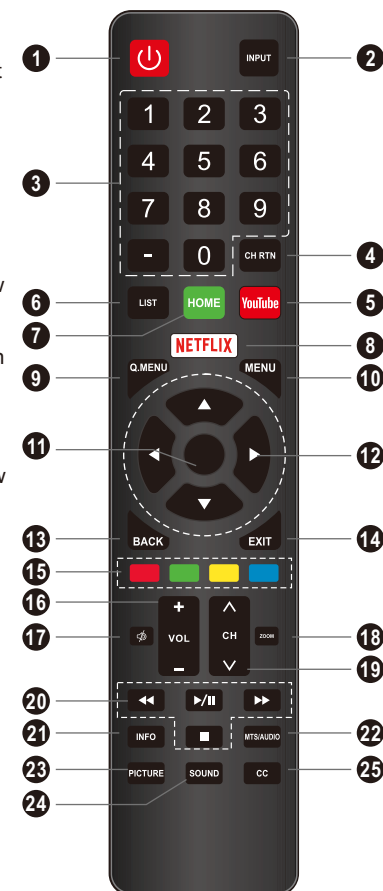

Remote-Control unit

17. MUTE: Press this button to cut off the sound of the TV set temporarily, press again to resume.

18. ZOOM: Press this button to select the aspect ratio of the screen.

19. CH ▲/▼: Press these buttons to change channel upward or downward.

20. DIGITAL MEDIA PLAYER CONTROL BUTTON: Include play/pause, stop, previous, next, backward, forward is used in USB mode. No record function. Please refer to relevant instructions in the section of multimedia player.

21. INFO: Display the program information.

22. MTS/AUDIO: In USB mode, press this button to switch audio track when movie is playing. In TV mode, press this button to switch MTS or Audio Language.

23. PICTURE: Press this button to select among Sports, Normal, Mild, User.

24. SOUND: Press this button to select among Standard, Sports, Movie, Music, User.

25. CC: Display CC function menu in TV/AV mode.

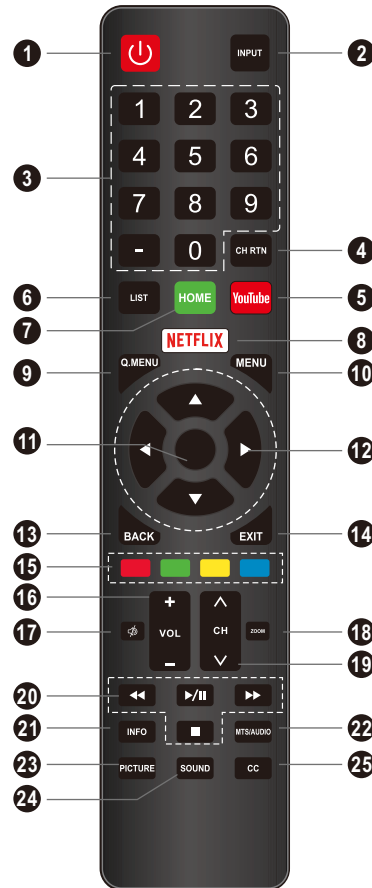

Main Menu User Guide

1 Input Setup

Press **INPUT** key on the remote control to enter "INPUT SOURCE" menu. Use **◀/▶** key to select an input source and press **ENTER** key to confirm.

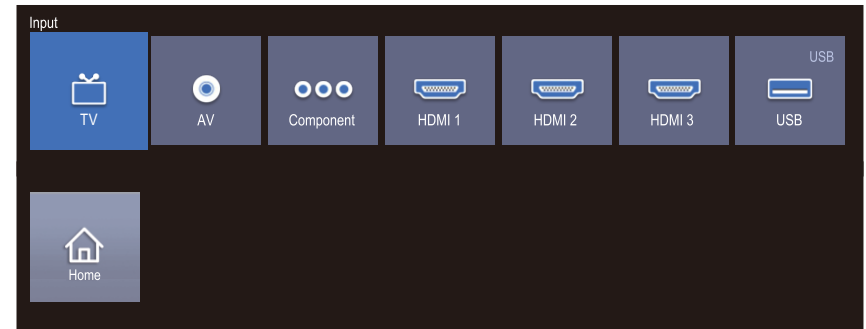

2 Channels Selection

There are four ways to select channel:

1) Using number keys, and "**ENTER**" keys on the remote control to select channel directly. To select channel 90, press **9** → **0** → **ENTER**. When you use the number buttons, you can directly select channels that were either erased or not memorized.

2) Using CH **◀/▶** key on the remote control or on your TV to select channel. When you press the CH **◀/▶** key, the TV changes channels in sequence. You will see all the channels that the TV has memorized. You will not see channels that were either erased or not memorized.

3) Press **CH RTN** key to return to previous channel, press it again to return to current channel.

To quickly switch between two channels that are far apart, tune to one channel, then use the number keys to select the second channel. Then use the **CH RTN** button to quickly alternate between them.

CH RTN is not activated if no channel has been changed after TV turning on.

4) Select channels from "Channels List" or "Favorite List". Press "**ENTER**" key to choose from "Channel List" menu.

3 Volume Adjustment and Mute Setup

Volume adjustment

Press **VOL+ / -** key on the remote control or the TV to display "Volume" menu, adjust the volume of TV between 0 to 100 by using **VOL+ / -** key:

To increase the volume, press **VOL +** key;
(To decrease the volume, press **VOL -** key;

Mute

Press "**MUTE**" and the sound cuts off. The MUTE icon will appear in the lower-right corner of the screen.

To resume sound, press the "**MUTE**" button again, or simply press the VOL+ key.

4 Current Channel Information

Press "INFO" key on the remote control to view current channel information, the indications of channel information are listed in the following table.



Press "EXIT" key on the remote control to exit this OSD.

Picture

1. Press **MENU** key to display the main menu on the screen.
2. Press **▲/▼** key to select "Picture" option.
3. Press **▶** key to enter "Picture" submenu.

Sharpness

Adjusts the outline of objects to either sharpen them or make them more dull.

Tint

Adjusts the Tint of the picture.

Backlight

Automatic brightness adjustment, does not support manual brightness adjustment.

Color Temperature

You can change the color of the entire screen according to your preference.

1. Press **▲/▼** key to select "Color Temperature" option.
2. Press **◀/▶** key to select one color temp.

Aspect Ratio

1. Press **▲/▼** key to select "Aspect Ratio" option.
2. Press **◀/▶** key to change the size of the picture on the size of the picture on the screen.

Noise Reduction

Press p/q key to select the Noise Reduction mode. You can select the right mode to match the pictures.

Open HDR

1. Press **▲/▼** key to select "Open HDR" option.
2. Press **◀/▶** key to select "On" or "Off".

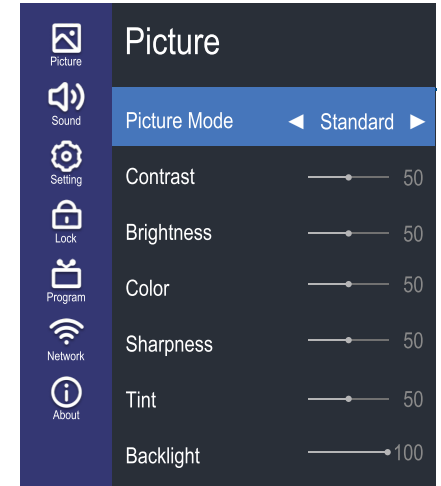

Sound

1. Press **MENU** key to display the main menu on the screen.
2. Press **▲/▼** key to select "Sound" option.
3. Press **▶** key to enter "Sound" submenu.

Sound Mode

You can select the type of the special sound effect to be used when watching a given broadcast.

Your TV has five sound settings ("Standard", "Music", "Movie", "Sport", "User") that are preset at the factory.

1. Press **p/q** key to select "Sound Mode" option.
2. Press **t/u** key to select one sound mode.

Standard: Selects the normal sound mode.

Music: Provides clear and live sound for music.

Movie: Provides live and full sound for movies.

Sports: Emphasizes bass over other sounds.

User: Selects your custom sound settings.

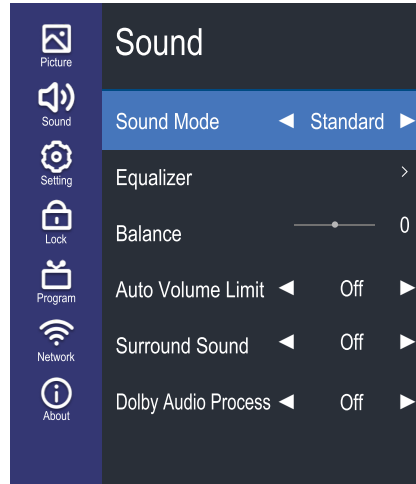

Equalizer

Set sound equalizer mode.

Balance

If the volumes of the left speaker and the right speaker are not the same, you can adjust the "Balance" to suit your personal preference.

1. Press **▲/▼** key to select "Balance" option.
2. Press **◀/▶** key to decrease or increase the value of the item.

Auto Volume Limit

Each broadcasting station has its own signal conditions, and it is inconvenient to adjust the volume every time the channel is changed. "AVL" automatically adjusts the volume of the desired channel by lowering the sound output when the modulation signal is high or by raising the sound output when the modulation signal is low.

1. Press **▲/▼** key to select "AVL" option.
2. Press **◀/▶** key to select "On" or "Off".

Surround sound

This is used to turn on surround sound to gain better sound effect.

1. Press **▲/▼** key to select "Surround sound" option.
2. Press **t/u** key to select "Surround" or "Off".

Dolby Audio Process

This is used to set DAP.

1. Press **▲/▼** key to select "Dolby Audio Process" option.
2. Press **◀/▶** key to select "On" or "Off".

Sound

Digital Output Type

This is used to set digital audio output.

1. Press **▲/▼** key to select "Digital Output Type" option.
2. Press **◀/▶** key to select a digital output type in DTV or HDMI mode.

Audio Delay

This used to set audio type

1. Press **▲/▼** key to select "Audio Delay", then press **Enter** or **u** button to enter sub-menu.
2. Press **◀/▶** key to decrease or increase the value of the item.

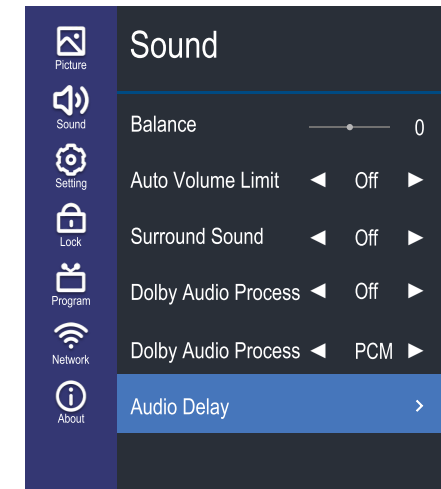

Setting

1. Press **MENU** key to display the main menu on the screen.
2. Press **▲/▼** key to select "Setting" option.
3. Press **▶** key to enter "Setting" submenu.

Language

1. Press **▲/▼** key to select "OSD Language" setting.
2. Press **ENTER** or **▶** key to select a proper language for OSD.

OSD Time

Set the preferred amount of time for the OSD to be displayed on the screen.

Close Caption

1. Press **▲/▼** key to select "Close Caption" option.
2. Press **◀/▶** to select Close Caption mode.

Bluetooth(Optional)

1. Press **▲/▼** key to select "Bluetooth" option.
2. Press **ENTER/▶** key to enter Bluetooth submenu. (Optional items are only available for some models.)

Enable

Turn on or turn off the "Bluetooth" function.

Scan devices

Press **ENTER/▶** key to scan devices.

Link Setup

1. Press **▲/▼** key to select "Link Setup" option.
2. Press **▶** key to enter "Link Setup" submenu.

Link-CEC

Turn on or turn off the **Link-CEC** function.

HDMI ARC

Turn on or turn off the **HDMI ARC** function.

Auto Power

Turn on or turn off the **Auto Power** function.

Auto Standby

Turn on or turn off the **Auto Standby** function.

Time

1. Press **MENU** key to display the main menu on the screen.
2. Press **▲/▼** key to select "Time" option.
3. Press **▶** key to enter "Time" submenu.

Auto Sync

You can modify the time of your TV set in Manual mode. In Auto mode, the "clock" is decided by the DTV signal. few minutes and don't turn off the power, it will turn off automatically when updating finish.

Clock --:--

When Auto Sync is on, the clock is got from DTV streams; Set the clock when Auto Sync is off.

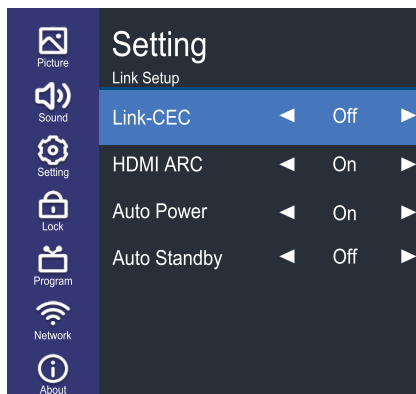
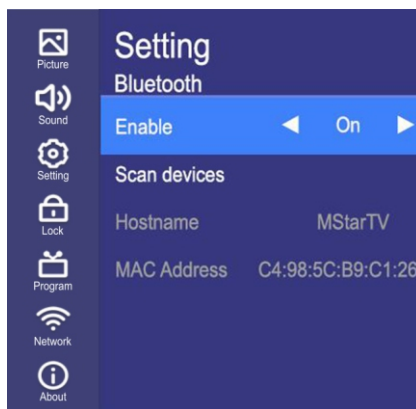
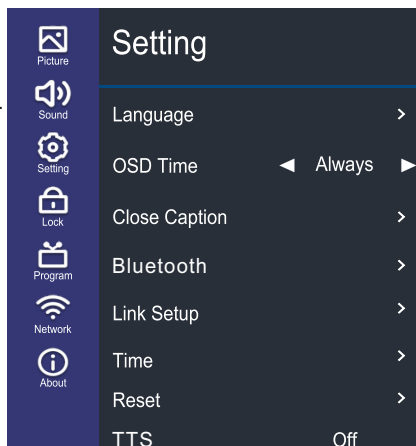

Setting

Off Time

In "Off Time" item, press **▶** button or **ENTER** button to enter the submenu, set the day & time to turn off the TV set.

On Time

In "On Time" item, press **▶** button or **ENTER** button to enter the submenu, set the time to turn on the TV set, when the TV set is in the standby mode. You can also choose which day to control you TV set in a week.

Sleep Timer

1. Press **▲/▼** key to select "Sleep Timer" option.
2. Press **◀/▶** key repeatedly until the desired time appears (Off, 10mins, 20mins, 30mins, 60mins, 90mins, 120mins, 180mins, 240mins).

Notes: The sleep timer you have set will be cancelled when the TV turns off or if a power failure occurs.

Notes: When the time is less than 60 seconds, remind information will be displayed on the screen. Press any key button to cancel timer function.

Auto Sleep

Press **▲/▼** key to select whether to open the No signal Power off features. If this function is opened, the TV will power off when there is no signal.

Time Zone

You can choose it to modify your time zone in the TV set.

1. Press **▲/▼** key to select "Time Zone" option.
2. Press **◀/▶** key to select time zone.

Reset

1. Press **▲/▼** key to select "Reset" option.
2. Press **▶** or **ENTER** key to confirm.
3. Press "Yes" to confirm again, TV will turn off auto maticly and change all setting to factory setting.

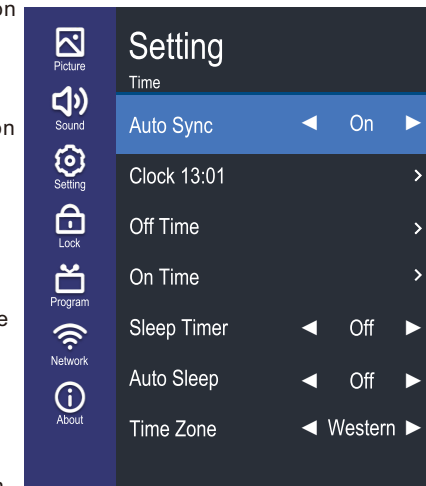

Lock

The "Lock" feature automatically locks out programming that is deemed inappropriate for children.

The user must first enter a Password before any of the lock restrictions can be set up or changed.

1. Press **MENU** key to display the main menu on the screen.
2. Press **▲/▼** key to select "Lock" option.
3. Press **▶** key to enter "Lock" submenu, "Enter Password" menu will appear, enter your 4-digit password to enter "Lock" submenu (the default and universal password is 1980).

Lock System

Set the Lock function on or off.

1. Press **▲/▼** key to select "Lock System" option.
2. Press **◀/▶** key to select "On" or "Off".

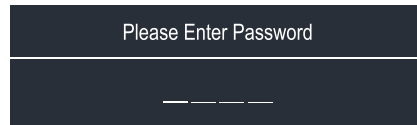

Set Password

1. Press **▲/▼** key to select "Set Password" option.
 2. Enter your 4-digit password to enter "Set Password" submenu. Choose any 4-digits for your new password and enter them. As soon as the 4 digits are entered, the cursor skipped to "Confirm Password" item, re-enter the same 4 digits, and your new password has been memorized.
- When the programs is locked, you can also press the menu key, Info key and so on. Then you can press **t/u** key to call back the input-password window.

USA TV

1. Press **▲/▼** key to select "USA TV" option.
2. Press left/right key to select.

USA MPAA

1. Press **▲/▼** key to select "USA MPAA" option.
2. Press OK key to open USA MPAA menu.

Canada English

1. Press **▲/▼** key to select "Canada English" option.
2. Press OK key to open Canada English menu.

Canada French

1. Press **▲/▼** key to select "Canada French" option.
2. Press OK key to open Canada French menu.

RRT Reset

1. Press **▲/▼** key to select "RRT Reset" option.
2. Press OK key to open RRT Reset menu.

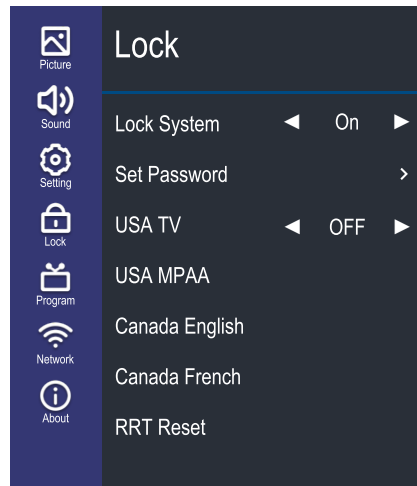

Program

1. Press **MENU** key to display the main menu on the screen.
2. Press **▲/▼** key to select "Program" option.
3. Press **▶** key to enter "Program" submenu.

Auto Tuning

Press **▲/▼** key to select "Auto Tuning" option. The number of searched channels will be shown on the screen.

Note: If you want to exit the whole searching, you can press EXIT button.

DTV Manual Tuning

You can use **◀/▶** button or input number to choose the channel. Then press OK button to search, the TV will store the DTV channel if there is a DTV signal present.

ATV Manual Tuning

In the ATV/DTV source, you can choose "ATV Manual Tuning" to enter "ATV Manual Tuning" menu.

Current CH

You can see the current channel number and you can press **◀/▶** button to choose the channel you want to modify. It will be searched and saved automatically.

Color System

Select the "Color System" option, press **◀/▶** on the remote control to change. The color system will be changed repeatedly in the order: PAL-N, PAL-M, NTSC or AUTO.

Fine Tune

In case of unfavorable image or sound of TV program, you can use "Fine Tune".

Frequency

You can see the frequency of the searched channels.

Save

You can see the channel you choosed.

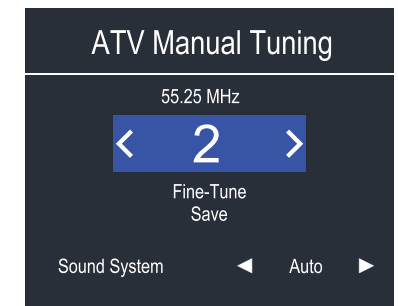
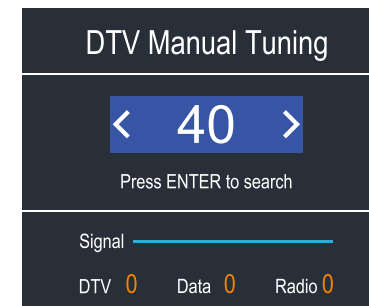
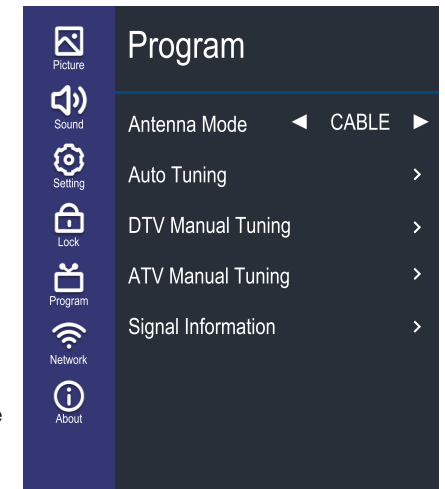

Program

Signal Information (Used only in DTV)

1. Press ▲/▼ key to select "Signal Information" option.
2. Press "ENTER" or ► key, you can see the information of the DTV channel.

NOTE:

Signal Quality/Signal Strength (DTV Only): Unlike analogue channels, which can vary in reception quality, digital channels must have perfect reception quality or you will not receive them at all. So, unlike analogue channels, you are not able fine tune a digital channel. If the signal strength indicates that the signal is weak, a possible solution is to adjust your antenna to increase the signal strength. Continue to adjust the antenna until you find the best position with the strongest signal.

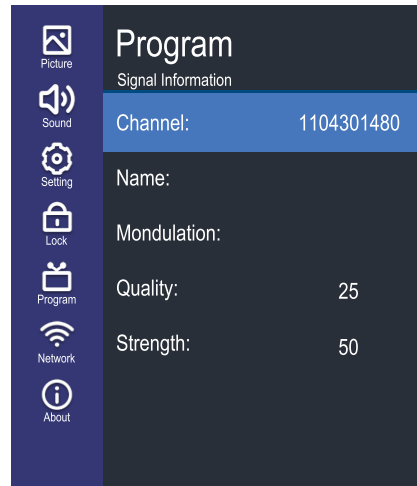

Network

1. Press MENU key to display the main menu on the screen.
2. Press ▲/▼ key to select "Network" option.
3. Press ► key to enter "Network" submenu.

Wi-Fi

When the Wi-Fi wireless network is going to be used, if select auto scan, select "Auto Scan" option and press key to select your Wi-Fi network, then enter password to connect your Wi-Fi network.

If select manual input, select "Manual Input" option, then setting up the IP, Netmask, Gateway and DNS in sequence. When the setting complete, press the "Connect" option.

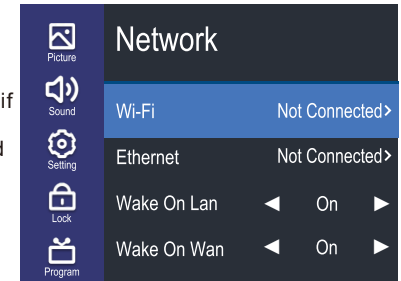

Ethernet

When the wired network is used, if select dynamic IP address setting, pitch on the "DHCP" in the "Configuration", and press the "Connect" button to enter. If select static IP address setting, pitch on the "Static" in the "Configuration", then setting up the IP, Netmask, Gateway and DNS in sequence. When the setting complete, press the "Connect".

Wake On Lan/Wake On Wan

Set the mobile phone to enter the same network segment as the TV. When the mobile phone enters Youtube, you will find a push icon in the upper right corner. After clicking, you can search for the TV, and then push to wake up the TV.

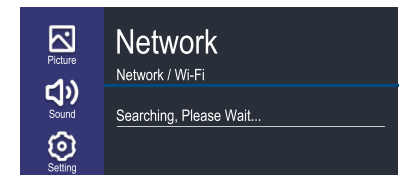
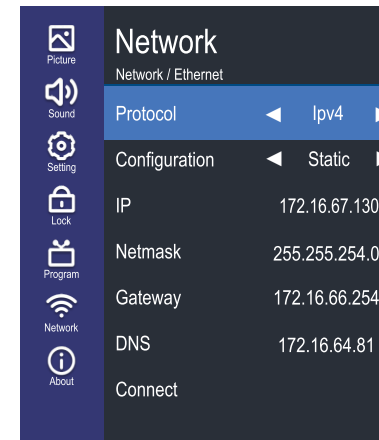
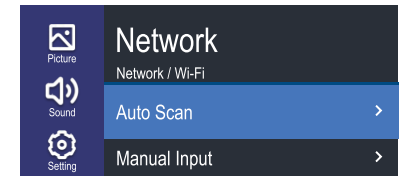

About

1. Press **MENU** key to display the main menu on the screen.
2. Press **▲/▼** key to select "About" option.
3. Press **▶** key to enter "About" submenu.

Netflix Netflix Deactive

1. Press **▲/▼** key to select "Netflix Deactive" option.
2. Press **▶** or **ENTER** key to confirm.
3. Press "YES" to confirm again, the Netflix will be activated.

Terminate Netflix

1. Press **▲/▼** key to select "Terminate Netflix" option.
2. Press **▶** or **ENTER** key to confirm.
3. Press "YES" to confirm again, the Netflix will be terminated.

Netflix ESN

Display the Netflix Esn information.

Netflix Version

Display the Netflix version.

View End-User License Agreement

1. Press **▲/▼** key to select "View End-User License Agreement" option.
2. Press **▶** or "ENTER" key to display View End-User License Agreement.

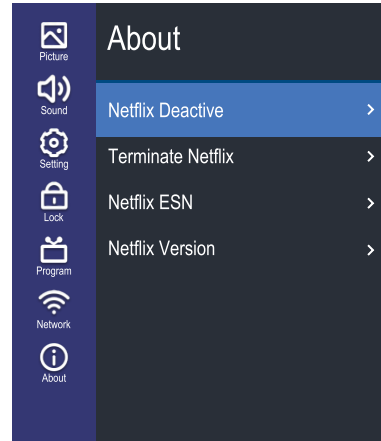

System information

1. Press **▲/▼** key to select "System information" option.
2. Press **▶** or "ENTER" key to display system information.

NetReady Information

1. Press **▲/▼** key to select "NetReady Information" option.
2. Press **▶** or "ENTER" key to display netready information.

Software Update(USB)

When the TV need to be updated, please copy the new software to a USB storage to TV, then operating by following steps.

1. Press **▲/▼** key to select "Software Update" option.
2. Press **▶** or **ENTER** key to confirm.
3. Press "YES" to confirm again, the TV will update by USB. Please wait a few minutes and don't turn off the power, it will turn off automatically when updating is finish.

Internet Update Check

This can update TV through internet.

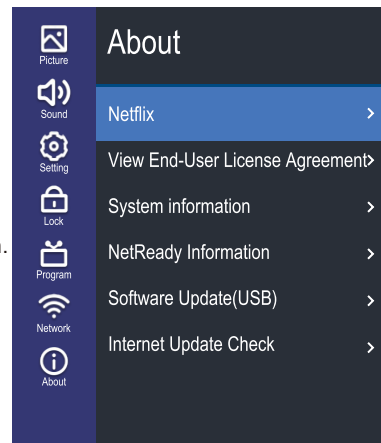

Home Operation

Setup wizard

Press "HOME" key to enter home interface.

1. SOURCE setup

Press arrow key to select a input source and press ENTER key to confirm.

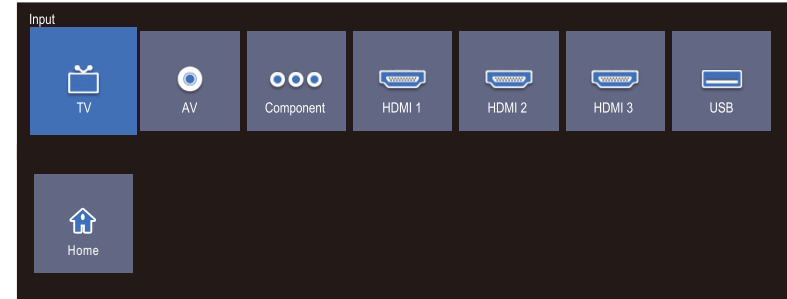

2. APP setup

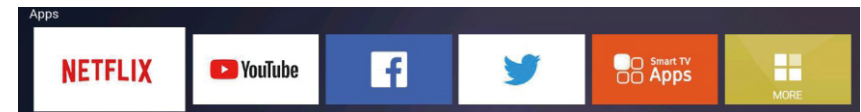

1) NETFLIX

Use arrow key to Select  icon, then press "ENTER" key to enter NETFLIX.

Use arrow button to select one video and press "ENTER" key to play.

Press "MENU" key to exit playing.

Use arrow key to browse the pages. press "MENU" key to return to main menu and press "EXIT" key to exit.

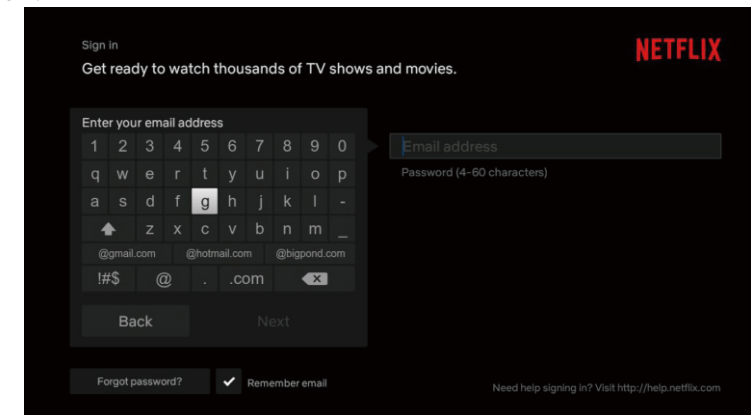

2) Youtube

Use arrow key to Select  icon, then press "ENTER" key to enter Youtube.

Use arrow button to select one video and press "ENTER" key to play. Press "MENU" key to exit playing.

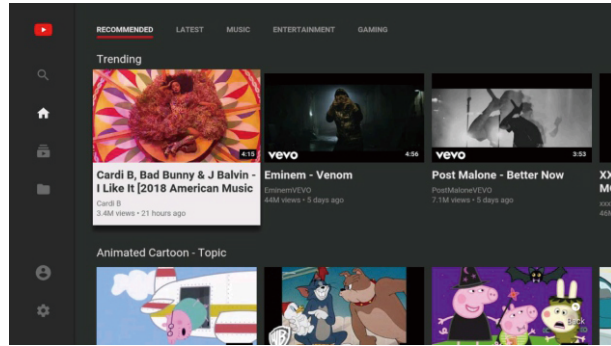

Press ▼ key to open or close control menu when playing.

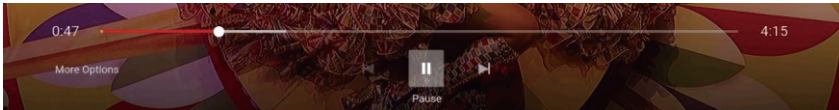

3) Facebook

Use arrow key to Select  icon, then press "ENTER" key to enter Facebook.

Input the right Email and password, select "log In" button, then press "ENTER" key to log in. Press arrow key to browse the pages and press "ENTER" key to view. Press "EXIT" key to exit Facebook.

Red key: log in or log out Facebook.
Green key: refresh current page.

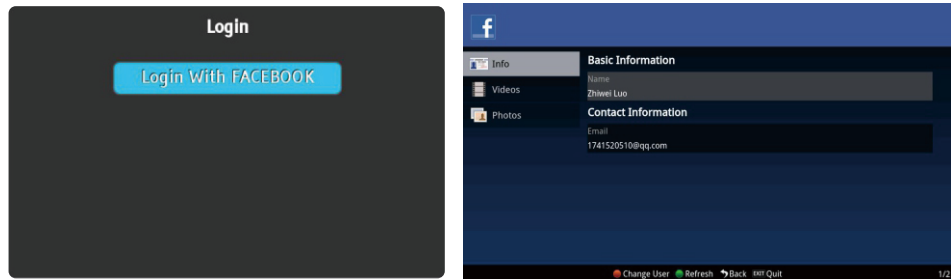

4) Twitter

Use arrow key to Select  icon, then press "ENTER" key to enter Twitter.

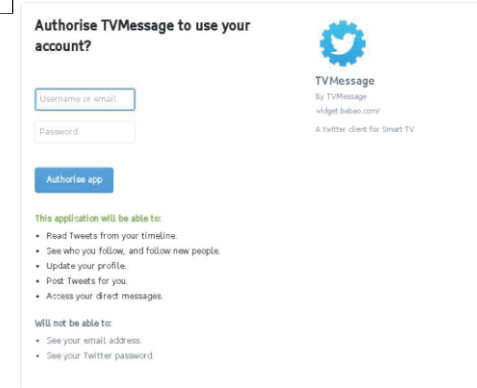

Input the right Email and password, then select "Authorize app" button and press "ENTER" key to log in.

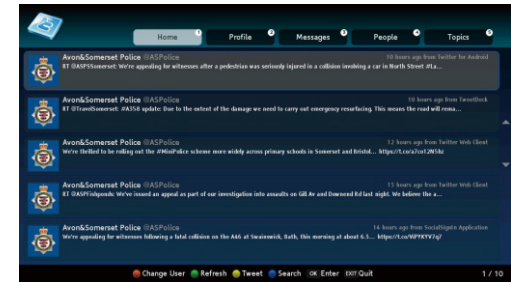

Use arrow key to browse the pages. press "Back" key to return to main menu and press "EXIT" key to exit twitter.
Red key: log in or log out twitter.
Green key: refresh current page.
Yellow key: write new tweet.
Blue key: Search tweet.

Internet

5)YAHOO Weather

Use arrow key to Select  icon, then press "ENTER" key to enter YAHOO weather.

Input a city to get the weather information.

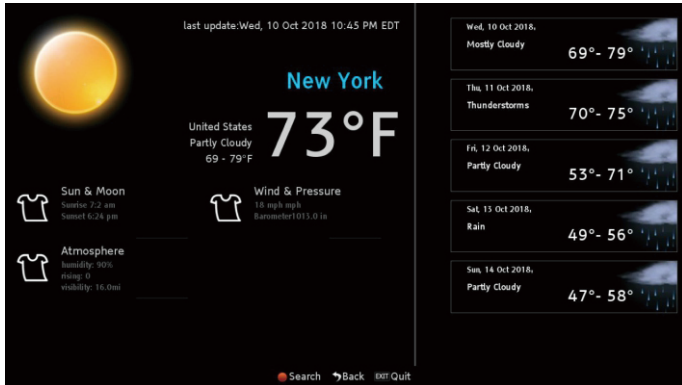
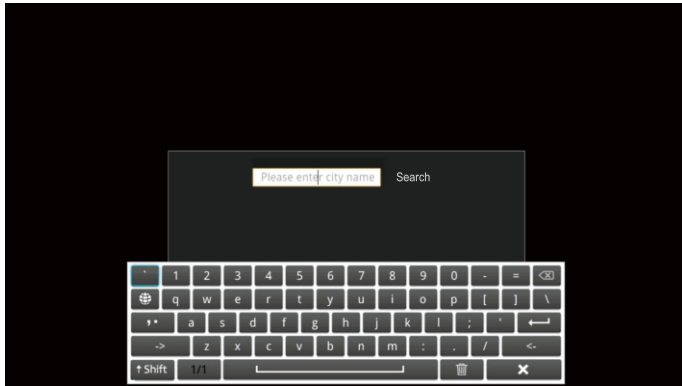

Introduction

This TV is embedded with one USB port digital media player. It can find the devices support USB1.1/2.0, including flash disk, USB hard disk and digital camera. It supports functions as: Display pictures. Play music files, Play video files.

Notice:





1. In order to avoid affecting the user's viewing experience, please use the better quality and shorter USB cable.
2. Play, preview some of the non-standard files may appear abnormal, please understand.

Explain:

1. Under the USB channel, you can use only the remote control.
2. Play Control menu to enter the playing surface to press the menu button pop-up menu

Data	Format
Picture	JPEG
Music	Mp3
Video	Motion-JPEG

Troubleshooting

Problem	Possible cause	Possible solution
No picture and sound.	<ul style="list-style-type: none"> • The power adaptor is not plugged in or not working. • The wrong input source is selected. • The input source has failed to connect with the TV or is not turned on. 	<ul style="list-style-type: none"> • Plug the power into a suitable outlet. • Select the correct input source. • Make sure the input source is correctly connected and turned on.
No sound.	<ul style="list-style-type: none"> • The volume control is set to minimum. • The mute  button on the remote control has been pressed • An incorrect sound system mode is set. 	<ul style="list-style-type: none"> • Press the  button to increase the volume. • Press  or the (or ) button to restore/increase the volume. • Set a correct sound system mode from the main menu to match your TV source.
No picture, or monochrome picture only.	<ul style="list-style-type: none"> • The colour system setting does not match the program. • The sound system setting does not match the program. 	<ul style="list-style-type: none"> • Select the appropriate colour system setting. • Select the appropriate sound system setting. (If unsure, use Auto settings where available).
Sound or picture interference.	<ul style="list-style-type: none"> • Some equipment that causes interference is close to the TV. • More than one device is plugged into the same power outlet. • An incorrect sound system mode is set. 	<ul style="list-style-type: none"> • Keep interference-causing equipment away from the TV. • Plug the power adaptor into another, separate power outlet. • Set a correct sound system mode from the main menu to match your TV source.
PVR recording failed, or "DISK NOT READY" is displayed.	<ul style="list-style-type: none"> • You may not have removed your USB device after the last recording, which is necessary to protect the device from damage. 	<ul style="list-style-type: none"> • Remove the USB device after each recording if you experience recording problems. If "DISK NOT READY" is displayed, remove the device, reconnect and then proceed with your recording.

Problem	Possible cause	Possible solution
DTV Picture Pixelation	<ul style="list-style-type: none"> • Poor Signal 	<ul style="list-style-type: none"> • Adjust the position or orientation of the TV antenna. • Check the antenna connection from the wall plate to the TV. • Try re-tuning the channels as the channel frequencies may be different in some areas.